

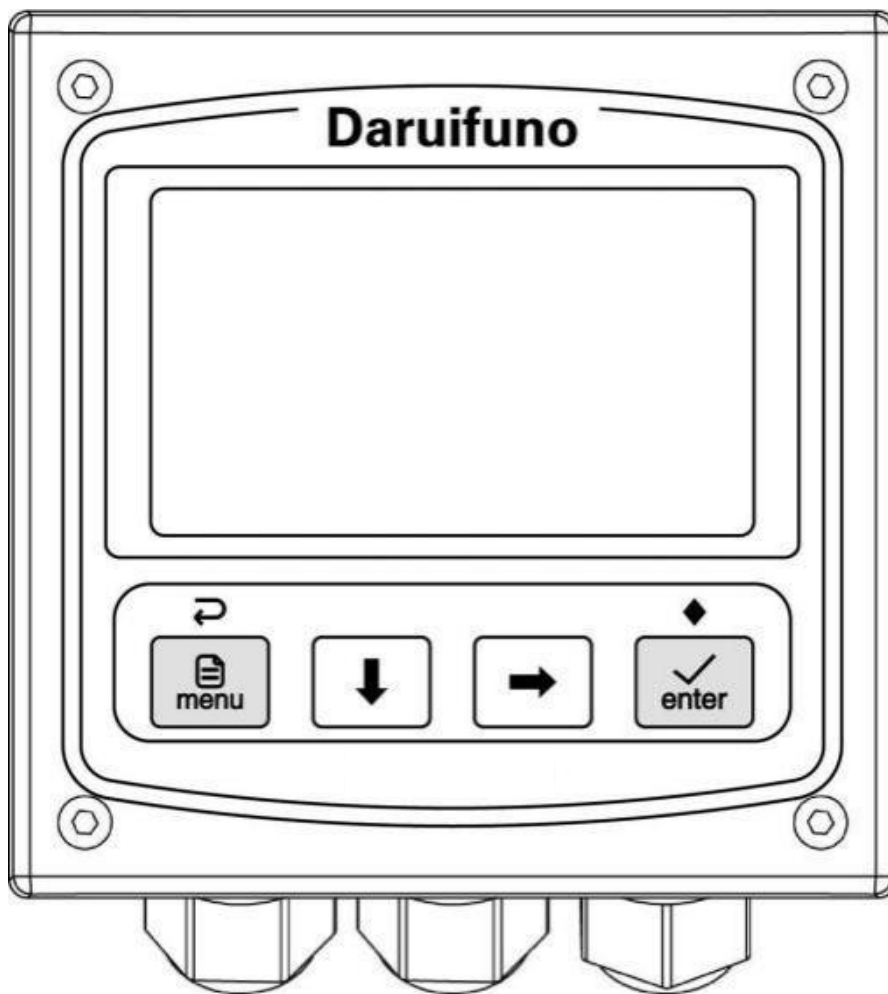

Online pH ORP Controller

User Manual



Important Safety Information

Please read and observe the following:

Please read this entire manual before unpacking, installation and operation, with particular attention to all danger warnings and precautions. Failure to do so may result in damage to the instrument or personal injury to the operator due to misuse. Do not install or use the instrument by any means other than those specified in this manual.

- After opening the analyzer case, the user may touch the instrument supply voltage. Please make sure to disconnect the power, before you open the analyzer cases. Analyzer housing assembly only low voltage, the operation is safe.

- The analyzer must be installed in accordance with relevant local codes and the professional and technical personnel, to comply with the analyzer's technical specifications and input ratings. If you are not sure which of the main power lines is the zero line, use a double-blade switch to disconnect the analyzer.

- As soon as a problem occurs with the analyzer, disconnect the analyzer from power to prevent any unintentional operation that could result in damage to the instrument. For example, it may be in an unsafe state when the following situations occur:

- (1) The analyzer appears visibly damaged ;

- (2) Analyzer fails to operate properly or provide the intended measurements;

- (3) Analyzer has been stored for a long period of time at temperatures over 70°C environment.

- Wiring or repair should be done by professionals, and only the power-off analyzer should be operated.

Power Wiring Note

1. Please install voltage stabilization and surge protection equipment that meets the instrument parameters at the power supply terminal to ensure that the power supply provided by the instrument is stable and reliable and meets the standards, otherwise the instrument will be irreversibly damaged due to poor power supply.

2. Damage caused by incorrect power supply is not covered by our quality guarantee.

3. Detailed parameters see the technical parameters.

Useful signs

In addition to installation and operation information, the manual also includes warning signs related to user safety, caution signs related to possible instrument failure, and note signs related to important and useful operating instructions.

Warning:

The warning sign is shown above, which warns the user might get hurt

Caution:

The caution sign is shown above, it reminds the user that the instrument may malfunction or be damaged



The note sign is shown on the left, warns the user of important information about operation.

Guarantee

Our company warrants the instrument for one year (12 months) from the date of delivery. Consumables and consumable parts in the equipment are not covered by the warranty. The terms of this warranty shall not apply if damage to the instrument occurs beyond the warranty period, or in the opinion of the company, the breakage or destruction of the instrument is due to improper use, lack of maintenance, improper installation, improper modification, abnormal environmental conditions, etc. The company's obligation under this warranty is limited to providing replacement or repair of this product, as the case may be. The product must be thoroughly cleaned to remove any contaminated chemicals before it is accepted for replacement or repair. Our obligations shall not exceed the price of the product itself. In no event shall the company be liable for damage caused by incidental or consequential damages, whether to persons or objects. The company shall not be liable for any other loss, damage or expense of any kind, including economic loss resulting from the installation, use or improper use of the product.

- For details, please refer to the product's quality promise with the product, and keep this manual and the quality promise properly.

Contents

Part 1 Introduction

Chapter 1	Overview	
	1.1 Technical parameters	1

Part 2 Installation

Chapter 2	Unpacking	2
Chapter 3	Installation	
	3.1 Installation location	2
	3.2 Dimension	3
	3.3 Panel mounting	3
Chapter 4	Electrical Installation	
	4.1 Power connection	4
	4.2 Wiring terminals definition	5

Part 3 Operation

Chapter 5	User Interface	
	5.1 Button.	6
	5.2 Display	7
Chapter 6	System Default Settings	8
Chapter 7	Menu Description	
	7.1 Probe set	10
	7.1.1 Probe select	10
	7.1.2 Probe cal	10
	7.1.3 Probe state	12
	7.1.4 Reset cal	12
	7.2 Temperature set.	12
	7.2.1 Probe type	12
	7.2.2 Temperature format	12
	7.2.3 Temperature cal	12
	7.2.4 Reset cal	12
	7.3 Alarm set	12
	7.3.1 Control function	12

7.3.2	Cleaning output	13
7.3.3	Cleaning state	13
7.3.4	ETEMP alarm	13
7.4	Current set	13
7.4.1	Output type	14
7.4.2	Channel selection	14
7.4.3	Upper value	14
7.4.4	Lower value	14
7.5	Communication set	14
7.5.1	Slave ID	14
7.5.2	Baud rate	14
7.5.3	Verify bit	14
7.5.4	Stop bit	14
7.6	System set	14
7.6.1	Language	14
7.6.2	Display speed	14
7.6.3	Backlight	14
7.6.4	Contrast set	14
7.6.5	Software	14
7.6.6	password	14
7.7	Test maintenance	15
7.7.1	Current cal	15
7.7.2	Relay testing	15
7.7.3	Current testing	15
7.7.4	Measurement method	15
7.7.5	Ambient temp	15
7.7.6	Meter reset	15
7.8	Setting list	15
Chapter 8	Quick Calibration Menu	16

Part 4 Repair and Maintenance

Chapter 9	General Remarks	
9.1	Maintenance	17
9.2	Troubleshooting	18
9.3	Fault checking	19

Appendix

A	Modbus register information	20
----------	------------------------------------	-----------

Part 1 Introduction

Chapter 1

Overview

Industrial online pH (ORP) controllers are suitable for continuous monitoring of pH (ORP) values of aqueous solutions in various industries.

1.1 Technical parameters

Measuring Range	pH: -2.00~16.00pH	
	ORP: $\pm 2000\text{mV}$	
	Temp: $-10^{\circ}\text{C}\sim 150^{\circ}\text{C}$	
Resolution	0.01pH/1mV/0.1 $^{\circ}\text{C}$	
Accuracy	$\pm 0.02\text{pH}/\pm 2\text{mV}$	
Temperature Compensation	NTC10K/PT1000 automatic or manual	
Relay Control	Channel Quantity	2
	Control Type	pH high / low alarm ORP high / low alarm Temperature high / low alarm Ambient temperature alarm
	Contact Type	SPST, software configurable always on/off operating mode
Current Output	Contact Capacity	3A 250VAC
	Channel Number	2
	Corresponding Channels	pH/ORP/TEMP
	Output Type	active 4~20mA or 0~20mA
	Maximum Load	1000 Ω
Communication Interface	a RS485 MODBUS-RTU	
Operating Environment	0~+60 $^{\circ}\text{C}$, relative humidity 0~95%, no condensation	
Storage Environment	-20~+70 $^{\circ}\text{C}$, relative humidity 0~95%, no condensation	
Power Supply	100~240VAC or 18~36VDC, 3W MAX	
Installation Method	Panel mounting	
Instrument Size	100*100*120 (unit: mm)	
Protection Grade	IP66	
Instrument Weight	500g	

Note: APX1-C1 series meters are not equipped with PT1000 automatic compensation

Note: APX1-C1 series meters are not equipped with a second current

Note: APX1-C1 series meters are not equipped with communication functions

Part 2 Installation

Chapter 2

Unpacking

After unpacking, it is recommended that the shipped cardboard boxes and packing materials be saved for instrument storage or reshipment. Inspect equipment and packing materials for signs of damage during shipment. If there are signs of damage, immediately notify the person delivering the shipment.

Chapter 3

Installation

3.1 Installation location

The installation location of the meter is:

Unaffected by weather (rain, snow, ice, dust, etc.)

- Clean, dry and with little or no vibration
- Keep away from corrosive liquids
- Within ambient temperature limits (32~140°F or 0~60°C)

Caution:

Analyzer directly exposed to the sun,
its operating temperature may exceed
its specified limit temperature,
and will reduce the visibility of the display.



Note: Please read this operation manual thoroughly before installation to avoid damage to the instrument due to wrong wiring.

- Please choose a well-ventilated location to install the instrument to avoid direct sunlight.
- The electrode signal transmission must use specific cables or cables provided by our company, and cannot be replaced by random wires.
- When using AC220V power supply, avoid using three-phase power supply to avoid power spike interference (if power spike interference occurs, the power supply of the controller can be separated from the power supply of the control device, so that the controller uses a separate power supply, or the coil ends of all electromagnetic switches and power control devices are connected to spike absorbers to eliminate spikes, such as dosing machines, mixers, etc.).
- It is generally recommended that the controller be accessible to the electrode during installation.
- Avoid corrosive liquids, or need to protect and isolate the environment.

3.2 Dimension

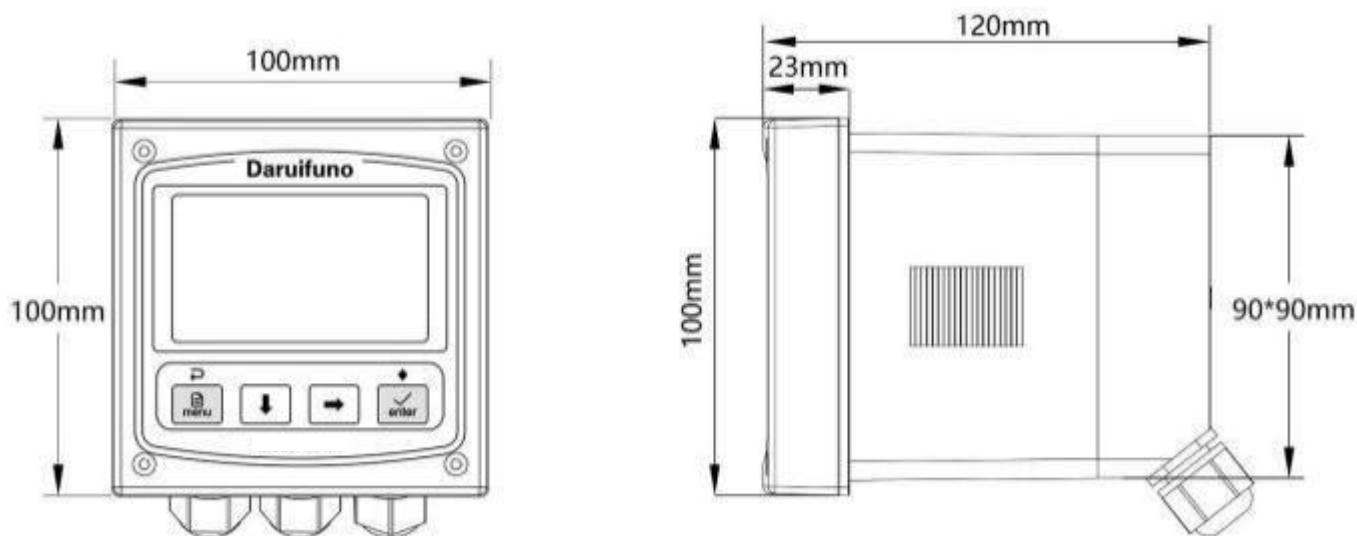

Figure 3-1 Instrument dimension

3.3 Panel mounting

When the controller is selected for panel mounting, the user passes the fixing clips through the back of the instrument until it is tightened, and the mounting dimensions and diagram are shown below:

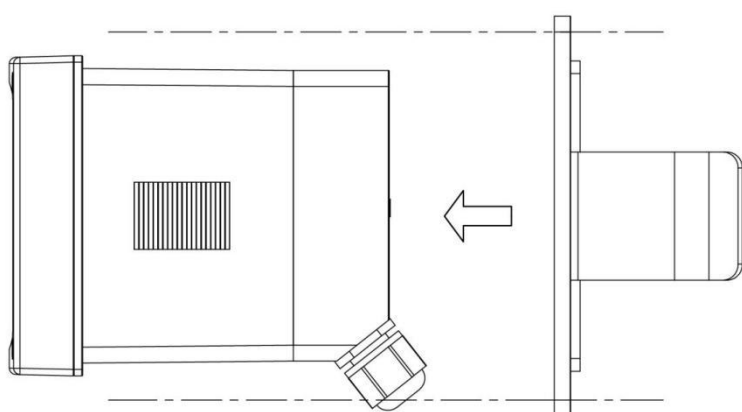

Figure 3-2 Panel mounting

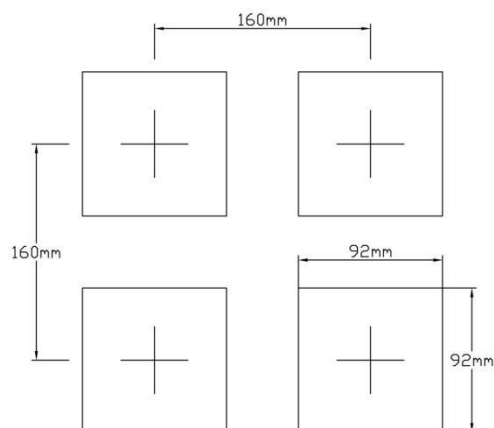

Figure 3-3 the minimum opening spacing

4.1 Power connection

Two types of power supply: AC power supply 100~240VAC and DC power supply 18~36VDC.

After unscrewing the screws at the back of the meter and taking off the cover, you can see two rows of terminals.

Figure 4-1 indicates the location and name of the access terminals for both power supplies.



Note: Before connecting AC power, be sure to cut off the power supply

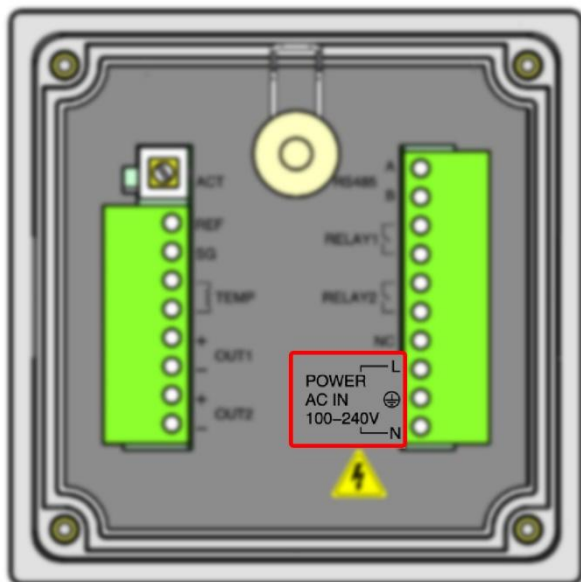

AC power supply: 100~240VAC

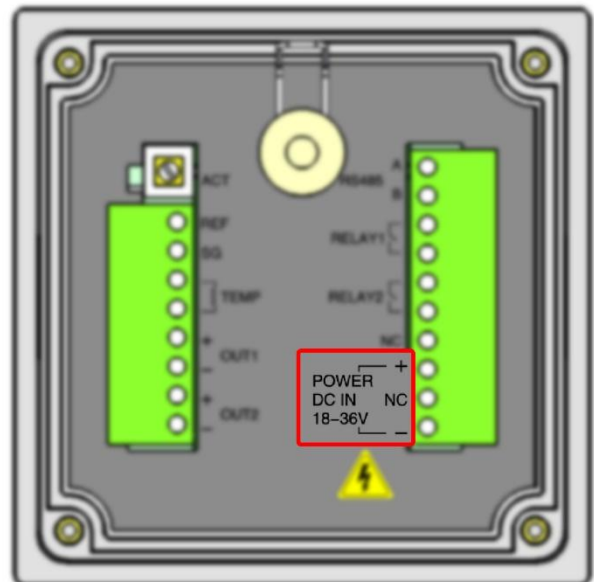

DC power supply: 18~36VDC

Figure 4-1 Two types of power terminals

Two kinds of power terminals are defined in Table 4-1:

POWER AC IN 100-240V	L	AC power fire wire input	POWER DC IN 18-36V	+	DC power positive
	⊕	AC power ground wire		NC	Floating terminal
	N	AC power zero line input		-	DC power negative

Table 4-1 Two types of power terminals definition

4.2 Wiring terminals

The terminal locations and names are shown in Figure 4-2:

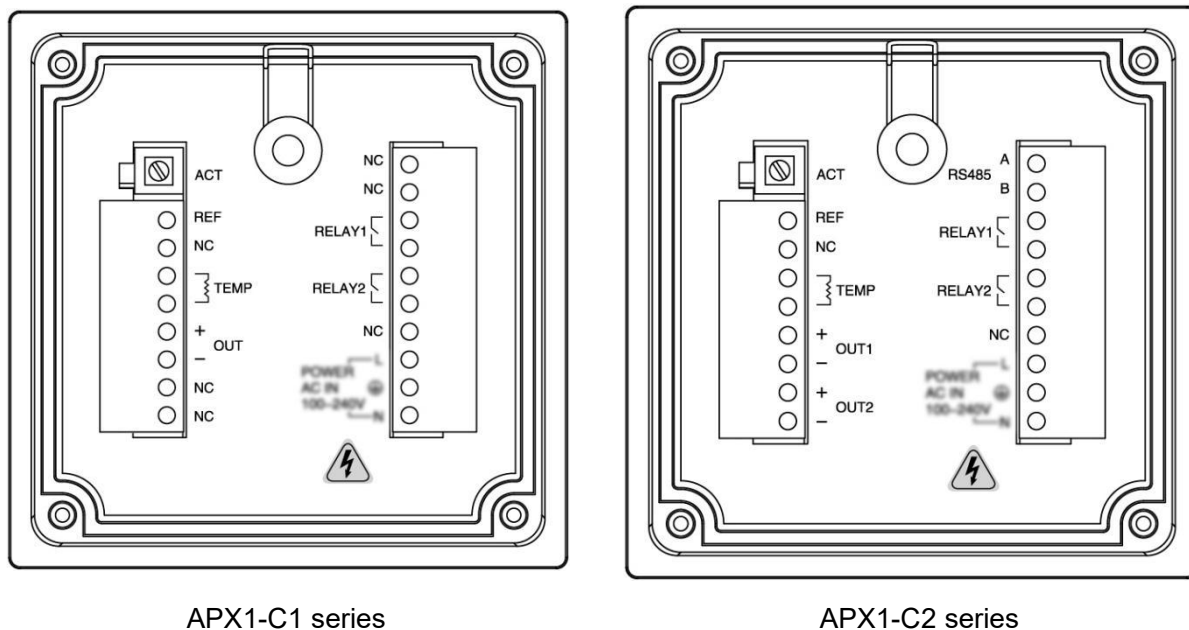

Figure 4-2 terminal blocks

The following table is the terminal definition:

ACT	pH(ORP) probe indication terminal		Support by APX1-C2 series	A	RS485 signal D+(A) terminal
REF	pH(ORP) probe reference terminal			B	RS485 signal D-(B) terminal
TEMP	Temperature probe input terminal		RELAY1	Relay 1 contact	
	Temperature probe input terminal			Relay 1 contact	
OUT1	+	Current 1 Output positive	RELAY2	Relay 2 contact	
	-	Current 1 Output negative		Relay 2 contact	
OUT2	+	Current 2 Output positive	NC	Floating terminals	
	-	Current 2 Output negative			

Part 3 Operation



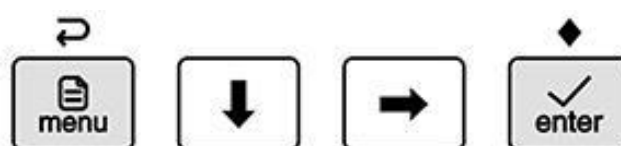

Chapter 5

User Interface

The instrument panel consists of a display screen and four buttons, which are the MENU button, the ENTER button, and the down and the right direction button. As shown below:



5.1 Button

Button	Function
	In the main menu, press this key to return to the measurement mode In the sub menu, press this key to return to the previous menu When setting the value, press this key to abandon the modification and return to the previous menu During calibration, press this key to cancel the calibration process In measurement mode, long press this key to enter the main menu
	In measurement mode, press this key to switch between two secondary display modes In the menu, press this key to move the cursor down When setting the value, press this key to subtract 1 from the value, or to change the sign bit
	In measurement mode, press this key to switch between two measurement value display modes (only pH measurement mode is available) In the menu, press this key to move the cursor up When setting the value, press this key to add 1 to the value
	In measurement mode, long press this key to open the quick calibration menu In the menu, press this key to enter the sub menu or the item selected by the cursor When setting the parameter (value or option), press this key to save the setting and return to the previous menu

5.2 Display

The meter normally displays the measurement interface after power-on. The specific information is as follows:

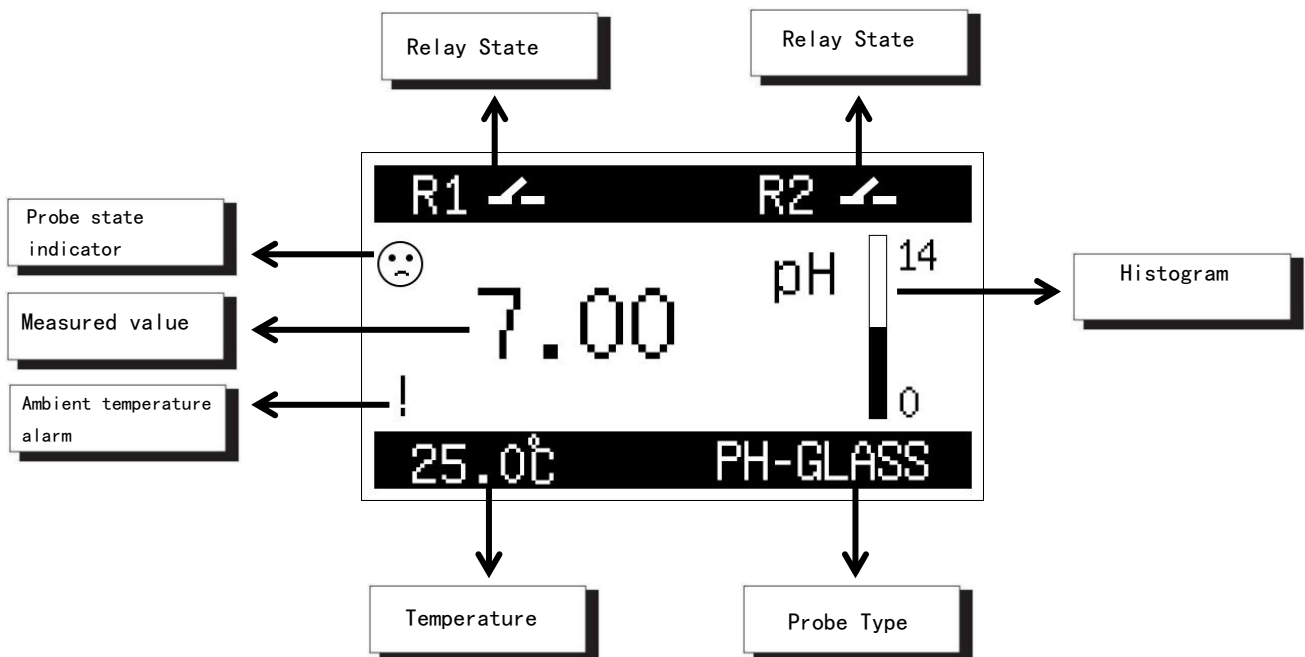

Relay state: Indicates the current relay state, on or close.

Measured value: Display the current PH (ORP) measurement value, if ">" or "<" symbol appears in front of the measurement value, it means the measurement is out of range. In

pH measurement mode, press the button  to switch between "pH measurement value" ↔ "mV/pH measurement value".

Histogram: Indicates the ratio of the current measured value to the range.

Ambient temperature alarm: When the operating environment temperature exceeds 50°C, a "!" will appear on the screen, indicating that the working environment temperature of the instrument is too high, and heat dissipation measures are needed.

Probe state indicator: The instrument diagnoses the electrode zero point and slope during calibration and maintenance. When the electrode selection menu is set to "pH glass electrode", if the electrode slope exceeds the standard value $\pm 20\%$ or the zero point exceeds $\pm 1\text{pH}$, it will display "☹️", when the electrode selection menu is set to "ORP electrode", if the electrode slope exceeds the standard value $\pm 20\%$ or the zero point exceeds $\pm 100\text{mV}$, it will display "☹️".

Temperature: The temperature value is not displayed when the temperature electrode is not connected.

Probe Type: Displays the currently selected electrode type.

"PH-GLASS" means "pH glass probe"

"PH-ANT" means "pH antimony probe"

"ORP" means "ORP probe"

Chapter 6

System Default Settings

Menu title	Input range or option	Factory settings	
Probe Set			
Probe selection	pH-Glass, pH-Antimony,ORP probe	pH Glass probe	
Probe CAL	6.86pH CAL	0.00~14.00 pH	06.86pH
	4.01pH CAL	0.00~14.00 pH	04.01pH
	9.18pH CAL	0.00~14.00 pH	09.18 pH
	Offset	-14.00~+14.00 pH	+00.00 pH
Probe state	Zero	-414.1~+414.1 mV	+000.0 mV
	Acid slope	0~99.99 mV/pH	59.16 mV/pH
	Alkali slope	0~99.99 mV/pH	59.16 mV/pH
Temperature Set			
Probe type	NTC10K, PT1000(support by APX1-C2 series), manual	NTC10K	
Display format	xxx.x°C, xxx.x°F	xxx.x°C	
TEMP calibrate	-100.0~+100.0°C	+025.0°C	
Alarm Set			
Relay 1	Function set	PH/ORP control, TEMP control, clean relay,ETEMP alarm	PH/ORP control
	On value	0~14.00pH	14.00pH
	Off value	0~14.00pH	13.80pH
Relay 2	Function set	PH/ORP control, TEMP control, clean relay, ETEMP alarm	PH/ORP control
	On value	0~14.00pH	00.00pH
	Off value	0~14.00pH	00.20pH
Current Set			
Current 1	Output type	4-20mA, 0-20mA	4-20mA
	Channel	Main CH, Temperature	Main CH
	Upper value	0~14.00pH	14.00pH
	Lower value	0~14.00pH	00.00pH

Current 2 Support by APX1-C2 series	Output type	4-20mA, 0-20mA	4-20mA
	Channel	Main CH, Temperature	Temperature
	Upper value	0~100°C	100.0°C
	Lower value	0~100°C	000.0°C
Communication Set			
Note: APX1-L1, APX1-C1 series meters are not equipped with communication functions			
Slave ID	001~254Add		001Add
Baud rate	4800, 9600, 19200, 38400, 57600,		9600
Verify bit	None, odd parity, even parity		None
Stop bit	1bit, 2bit		1bit
System Set			
Language	Chinese. English		English
Display speed	Buffers 2, buffers 4, buffers 8, buffers		Buffers 2
Backlight	Scanty power, always on		Scanty power
Scanty power	01min, 05mins, 10mins		01min
Contrast set	0~63		25
Password	000000~999999		000000
Servings			
Measure mode	probe measurement, analog		probe measurement
Ambient temperature	-999.9~+999.9°C		+025.0°C
Buzzer alarm	Close, open		Close

In the measurement interface, long press the MENU button to enter the menu. The following is a detailed introduction to the menu content.

7.1 Probe set

7.1.1 Probe select

Select the type of electrode connected to the meter.

7.1.2 Probe cal

After the new electrode is connected to the meter, in order to eliminate the possible error between the electrode and the meter, the meter needs to be calibrated first. The specific steps are as follows:

A. pH calibration

I. Preparation before calibration

- a. pH 4.01 standard solution 100mL
- b. pH 6.86 standard solution 100mL
- c. pH 9.18 standard solution 100mL
- d. Deionized cleaning solution 300~500mL and some absorbent paper.

II. Zero calibration

(1) Clean the electrode with deionized cleaning solution, dry it with absorbent paper and put it into a standard solution with pH 6.86;

(2) Select “6.86pH CAL”, the screen will display “6.86pH”, press the key  to start calibration;

(3) “Please Wait...” appears on the screen and the current measurement value will be displayed later. After the calibration is completed, the meter automatically returns to the previous menu.



Note: During calibration, the user can press the key  to forcibly end the calibration, but this method is not recommended, because it may cause the meter to perform calibration when the measurement is not stable.



Hint: During calibration, press the key  to cancel the current calibration.

III. Slope 1 calibration

(1) Clean the electrode with deionized cleaning solution, dry it with absorbent paper and put it into a standard solution with pH 4.01;

(2) Select “4.01pH CAL”, the screen will display “4.01pH”, press the key  to start calibration;

(3) “Please Wait...” appears on the screen and the current measurement value will be displayed later. After the calibration is completed, the meter automatically returns to the previous menu.

IV. Slope 2 calibration

(1) Clean the electrode with deionized cleaning solution, dry it with absorbent paper and put it into a standard solution with pH 9.18;

Select “9.18pH CAL”, the screen will display “9.18 pH”, press the key  to start calibration;

“Please Wait...” appears on the screen and the current measurement value will be displayed later. After the calibration is completed, the meter automatically returns to the previous menu.



Note: The default setting of the meter is to use three solutions with pH values of 6.86, 4.01 and 9.18 respectively for calibration. If the user has other pH standard solutions, the value displayed on the screen can be modified to the pH value of the actual standard solution after selecting “4.01pH CAL”, “6.86pH CAL” and “9.18pH CAL”. However, the modified values in the three options should remain in the order of “pH4”<“pH7”<“pH9”.

B. ORP Calibration

I. Preparation before calibration

- a. ORP 86mV standard solution 100mL
- b. ORP 256mV standard solution 100mL
- c. Deionized cleaning solution 300~500mL and some absorbent paper.

II. Zero calibration

(1) Clean the electrode with deionized cleaning solution, dry it with absorbent paper and put it into a standard solution with ORP 86mV;

(2) Select “86mV CAL”, the screen will display +0086mV, press the key  to start calibration;

(3) “Please Wait...” appears on the screen and the current measurement value will be displayed later. After the calibration is completed, the meter automatically returns to the previous menu.

III. Slope calibration

(1) Clean the electrode with deionized cleaning solution, dry it with absorbent paper and put it into a standard solution with ORP 256mV;

(2) Select “256mV CAL”, the screen will display +0086 mV, press the key  to start calibration;

(3) “Please Wait...” appears on the screen and the current measurement value will be displayed later. After the calibration is completed, the meter automatically returns to the previous menu.



Note: The default setting of the meter is to use two solutions with ORP values of 86mV and 256mV respectively for calibration. If users have other ORP standard solutions, they can modify the displayed value to the ORP value of the actual standard solution after selecting “86mV CAL” or “256mV CAL”. However, the values in the two modified options should remain in the order of “ORP 86mV” < “ORP 256mV”.

Offset

If there is a fixed deviation between the measured and actual value of the electrode, the measurement deviation can be corrected by setting the value in this menu.

7.1.3 Probe state

You can view and set the current electrode zero and slope status values. These values will be automatically generated after calibration, and it is generally not recommended that users modify them by themselves. Experienced users can judge the service life of the electrode by checking these status values.

7.1.4 Reset cal

Reset the user calibration values to the factory default values.

7.2 Temperature set

7.2.1 Probe type

When the meter is connected to a pH electrode with temperature compensation, the menu needs to be set according to the temperature electrode type. If you need to input the compensation temperature manually, you can select "Manual Compensation" and set the manual compensation temperature.

7.2.2 Temperature format

Select the temperature display unit, either "°C" or "°F".

7.2.3 Temperature CAL

In this menu, enter the target temperature value and press the key  to calibrate the temperature measurement to the entered target value.

7.2.4 Reset cal

Reset the temperature calibration data to the factory default values.

7.3 Alarm set

The meter provides two completely independent relay output contacts, corresponding to the "Relay 1" and "Relay 2" menus, which allow the user to set the functions and parameters of the two relays separately.

7.3.1 Control function

When selecting "Main measurement control" or "Temperature control" in the "Main menu" -> "Alarm set" -> "Relay X" -> "Function set" menu, this relay is the control output relay. When "Main Measurement Control" is selected, the relay status is controlled by the pH (ORP) measurement; when "Temperature Control" is selected, the relay is controlled by the temperature measurement.

When "on value" > "off value" is set in the menu, the relay is high alarm control

When "on value" < "off value" is set in the menu, the relay is low alarm control

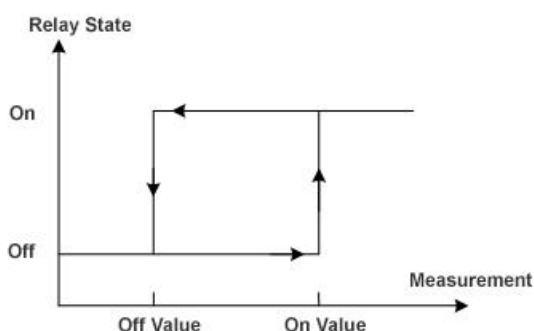

High alarm control

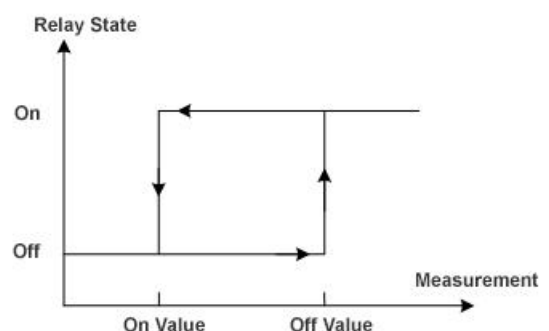

Low alarm control

7.3.2 Cleaning output

When selecting "Cleaning Output" in "Main Menu" -> "Alarm Set" -> "Relay X" -> "Function Set" menu, the relay is in the cleaning output state, the relay can be closed periodically to do cleaning control.

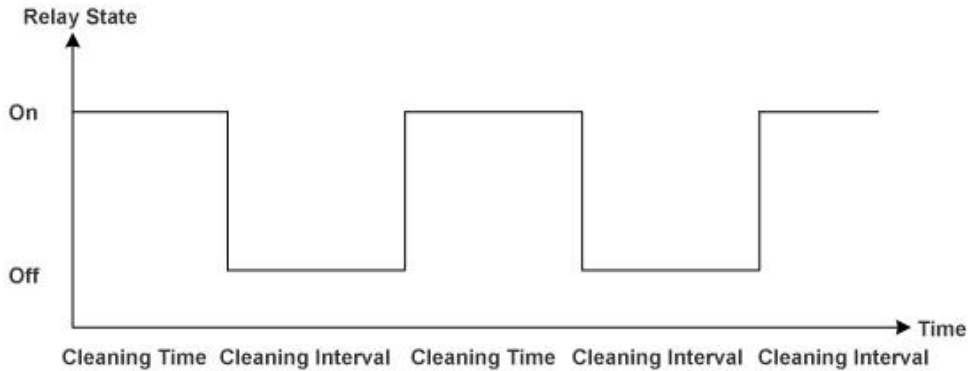

7.3.3 Cleaning state

Select the state of the measured value during cleaning.

After selecting "Keep", when cleaning, the measured value displayed maintains the value before the relay action. After selecting "Continuous", the measured value is the real-time value of continuous measurement.

7.3.4 ETEMP

When "ETEMP Alarm" is selected in the "Main Menu" -> "Alarm Set" -> "Relay X" -> "Function Set" menu, the relay is in the alarm control state. The relay is controlled by the meter's operating ambient temperature. When the ambient temperature exceeds 50°C, the relay closes.

7.4 Current set

The instrument provides up to two independently configurable current signals output, corresponding to the "Current 1" and "Current 2" menus, which allow the user to set the corresponding channels and the upper and lower limits of the two currents.

Note: APX1-C1 series meters are not equipped with a second current

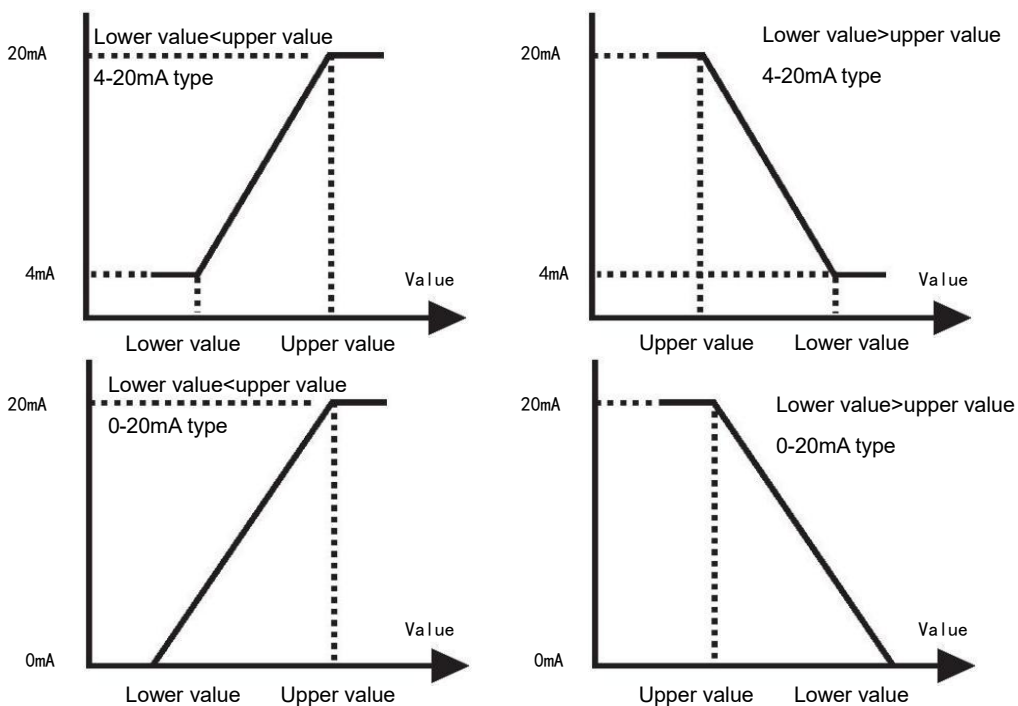

7.4.1 Output type

The output current type can be selected as “4-20mA” or “0-20mA”.

7.4.2 Channel selection

The measurement value corresponding to the current can be specified as the “main measurement channel” or “temperature channel”.

7.4.3 Upper limit value

Specify the measured value corresponding to the maximum output current.

7.4.4 Lower limit

Specify the measured value corresponding to the minimum output current.

7.5 Communication set

The instrument provides one digital communication interface, this menu can set the communication interface parameters.

Note: APX1-C1 series meters are not equipped with communication functions

7.5.1 Slave address

Sets the slave address used by the instrument in the communication

7.5.2 Baud rate

Select the baud rate to be used for the communication interface.

7.5.3 Check bit

Select the check mode, the default is “None”.

7.5.4 Stop bit

Select the number of stop bits, the default is “one bit”.

7.6 System set

7.6.1 Language

Select the system display text as “Chinese” or “English”.



7.6.2 Display rate

Adjust the rate of the change of the measured display value. The display rate from fast to slow is “buffers 2”, “buffers 4”, “buffers 8”, “buffers 16”, and “buffers 32”.

7.6.3 Backlight

Set the working mode of the LCD backlight. If it is set to “energy saving” mode, the backlight will automatically turn off if there is no key operation within the set time.

7.6.4 Contrast set

Set the contrast of the LCD display screen, key  to decrease the contrast, key  to increase the contrast.

7.6.5 Software

View program version information.

7.6.6 Password

Used to set the verification password to be entered when entering the menu in the measurement mode. The password is set to “000000” when leaving the factory, and you can enter the menu directly without password in the measurement mode. If the user sets other password, they will be prompted to enter the password when entering, and the password will be verified before entering the menu.

7.7 Test maintenance

7.7.1 Current cal

To calibrate the current output value, take calibrating current 1 20mA as an example, first connect the ammeter to the current 1 output terminal, then enter the menu “Test Maintenance” -> “Current Cal” -> “Current 1 “ -> “Calibrate 20mA”. Press the key to increase or decrease the value displayed on the screen until the ammeter reads 20mA, then press the key  to save the calibration result.



Note: When performing current calibration operation, for each current output, two points (4mA and 20mA) need to be calibrated to achieve the calibration effect.

7.7.2 Relay testing

Two sets of relays can be tested for on or off.

After entering, select “close” or “open” and the corresponding relay will make an open or close action.

7.7.3 Current testing

Two current outputs can be tested. First, connect the ammeter to the current output terminal to be tested, enter the menu and change the output current value by pressing the key, and verify whether the meter current output is correct by the ammeter reading.

7.7.4 Measurement method

The measurement value can be set to “Electrode measurement” or “Analog measurement”.

Electrode measurement: The measured value displayed on the screen is the value measured by the electrode.

Analog measurement: The measured value is displayed as the input value set by the user.

7.7.5 Ambient temp

Ambient temperature value: Display the current ambient temperature value.

Ambient temperature calibration: Calibrate the ambient temperature measurement value of the meter.

Buzzer alarm: Set whether the buzzer outputs an alarm sound when the ambient temperature is alarmed.

7.7.6 Meter reset

The instrument calibration parameters and all setting parameters can be reset to the factory default state.

7.8 Setting List

All calibration and setting parameters of the instrument can be viewed.

Chapter 8

Quick Calibration

The meter provides a quick calibration menu, which is convenient for the operators to quickly perform electrode calibration and maintenance work. The quick calibration menu is opened as follows: In the

measurement mode, long press the key , and after the the progress bar ends, the quick calibration menu will be opened. When the quick calibration menu is on, the secondary display area will change to a key function prompt.

In the pH measurement state, the quick calibration menu is used in the following way:

Open the quick calibration menu, and press the key  to resume calibration when the quick calibration menu is open;

Clean the electrode with deionized water, dry it with absorbent paper, put it into a standard solution with pH 6.86 and wait for the reading to stabilize;

Press the key  to start the calibration of the 6.86 pH point and wait for the calibration to finish.

Clean the electrode with deionized water, dry it with absorbent paper, put it into a standard solution with pH 4.01 and wait for the reading to stabilize;

Press the key  to start the calibration of the 4.01 pH point and wait for the calibration to finish.

Clean the probe with deionized water, dry it with absorbent paper, put it into a standard solution with pH 9.18 and wait for the reading to stabilize;

Press the key  to start the calibration of the 9.18 pH point and wait for the calibration to finish.

In the ORP measurement state, the quick calibration menu is used in the following way:

(1) Open the quick calibration menu, and press the key  to resume calibration when the quick calibration menu is open;

(2) Clean the electrode with deionized water, dry it with absorbent paper, put it into a standard solution with ORP 86mV and wait for the reading to stabilize.

(3) Press the key  to start the calibration of the 86mV point and wait for the calibration to finish.

(4) Clean the electrode with deionized water, dry it with absorbent paper, put it into a standard solution with ORP 256mV and wait for the reading to stabilize.

(5) Press the key  to start the calibration of the 256mV point and wait for the calibration to finish.

(6) Press the key  to exit the quick calibration menu.

Part 4 Repair and Maintenance

Chapter 9

General Remarks

9.1 Maintenance

The meter and the probe contain precision parts. Please make sure that the meter and the probe will not be subjected to any strong mechanical impact during use. There are no user maintenance parts inside the instrument.

Maintenance

Maintenance item	Maintenance content	Maintenance cycle
Instrument test	Visual inspection, check whether the meter display is normal and whether the housing is obviously damaged.	Every 4 weeks
Probe cleaning	The contamination and coverage of the probe reference oozing interface and the surface of the glass bulb will cause measurement errors or measurement instability. The probe needs to be cleaned regularly during use. The cleaning agent can be clean water, 3-5% hydrochloric acid, 3-5% NaOH, and daily detergent, etc.	7~15 days (According to the use environment, industrial wastewater is recommended to be cleaned once every 7~15 days)
Probe Cal	Contamination and blockage of the reference ooze interface will inevitably occur during the use of the probe, which can cause measurement errors. The use of standard solutions and regular calibration of the probe in use can correct the errors.	7~15 days (According to the use environment, industrial wastewater is recommended to be calibrated once in 7~15 days)
Probe Maintenance	The ionic balance on the surface of the glass membrane is changed when the pH probe is applied with strong acid, strong alkali or high temperature or after cleaning by harsh detergent, which will lead to measurement drift or measurement error. Soaking the probe with 3mol/L KCL solution after cleaning will help to improve the probe life.	After each cleaning

9.2 Troubleshooting

Fault phenomenon	Possible reason	Troubleshooting
No display	Power supply is not properly connected	Check if the power connection is normal and the power supply voltage is normal
	Incorrect contrast setting	Readjust the display contrast
 Appears on the screen	Probe calibration error	Recal the probe
	pH Antimony probe is being measured, but the menu is not set to Antimony probe	Set "PH-ANT" in the "Select probe" menu
	Probe damage	Replace probe
The screen appears "!" prompt	Instrument temperature is too high	Lower the ambient temperature or increase heat dissipation measures
	Ambient temperature calibration error	Recal the measured value of the meter's ambient temperature
Data communication does not respond	Data line polarity is reversed	Correct the polarity connection of the data line
	Communication parameter setting error	Check and reset communication parameters (slave address, baud rate, parity bits, stop bits)
	Communication cable failure	Replace or repair cables
Communication data error	Slave address conflict	Check whether the instrument slave address conflicts with other devices in the network and reset the slave address
Inaccurate current output	Parameter setting error	Check and reset current parameters
	Load impedance is too high	Check if the wire is too long or the load impedance is too high, and correct
	Current output drift generates errors	Recal the current output in the test maintenance menu

9.3 Fault checking

Judgment items	Judgment method
Whether the instrument measurement function is normal	Short connect the instrument terminal ACT and REF with a wire, and execute resume calibration in the menu, after the calibration is reset, the pH reading of the meter is $7.00 \pm 0.02 \text{pH}$, which means the instrument measurement function is normal
Whether the relay is normal	Switch between “close” and “open” in the test maintenance menu, listen to whether the relay has an action sound, and measure whether the resistance value of the relay is less than 10Ω when the relay is closed with a multimeter
Whether the current output is normal	Remove the wire of the current output terminal of the meter, connect the ammeter to the current output terminal of the meter, set different current values in the current test menu, and observe whether the ammeter reading is the same as the value set in the menu
Whether the zero point of pH probe is normal	Switch the meter display to “mV/pH measurement value” mode, put the probe into the standard solution with pH 6.86, if the mV reading is within $\pm 60 \text{mV}$ and stable, it means the probe zero point is normal

Appendix

A Modbus register information

1. Modbus RTU Overview:

The instrument acts as a slave on the network and supports the Modbus RTU communication protocol.

The data communication is initiated by the host and the first byte of the transmitted message is the target slave address. When the first byte is received by all slaves on the network, each slave will decode it to determine whether the message is sent to itself.

The transmission of the RTU message frame starts with a pause interval of at least 3.5 characters. After the last character is transmitted, a pause of at least 3.5 characters marks the end of the message frame. A new message can start after this pause. In the transmission process, the entire message frame must be transmitted in a continuous stream. If there is a pause of more than 1.5 characters before the completion of the message frame transmission, the receiving device will refresh the incomplete message and assume that the next byte is the start of the new message. Similarly, if a new message starts after the previous message frame in less than 3.5 character, the receiving device will assume that it is a continuation of the previous frame, and this will cause an error because the last CRC value cannot be correct.

The meter uses the function code 0x04 to complete the output of the measurement result and the output of the two current values.

2. Function code details (function code 0x04):

This function enables the host (upper computer) to obtain the real-time measured value from the slave (instrument). The value is specified as a single-precision floating-point type (that is, occupying 2 consecutive register addresses), and the corresponding parameter are marked by different register address.

The host can send the command frames to read single or all data results. The data frame format is as follows (all data are in Hex format):

Host send:

1	2	3	4	5	6	7	8
Slave address	Function code	Register start Address high 8 bit	Register start address low 8 bit	Register number high 8 bit	Register number low 8 bit	CRC low 8 bit	CRC high 8 bit
Addr	04	xx	xx	xx	xx	CRC	CRC

Slave response:

1	2	3	4	5	5+n	5+n+1	5+n+2	5+n+3
Device Address	Function code	Length	Data 1 high 8 bit	Data 1 low 8 bit	Data n high 8 bit	Data n low 8 bit	CRC low 8 bit	CRC high 8 bit
Addr	04	Len	xx	xx	xx	xx	CRC	CRC



- Note :**
- 1. Addr is the slave address, with an optional range of 0 x 01 to 0 x FE.**
 - 2. Len is the number of bytes of returned data.**

Examples:

Send frame: [01 04 00 02 00 02 D0 0B], the meaning is as follows:

[01]: Instrument address

[04]: Function code

[00 02]: Starting register address 0 x 02

[00 02]: Read 2 registers from the start address (read a single-precision floating-point data result)

[D00B]: CRC check data

Return frame: [01 04 04 CC CD 41 48 65 4D], the meaning is as follows:

[01]: Instrument address

[04]: Function code

[04]: The number of bytes returned (here 4)

[CC CD 41 48]: 0 x 4148CCCD (12.55 floating-point values, specific numerical meaning to find the corresponding address) (Note: 16-bit integer registers coalition of a single-precision floating-point, pay attention to the order of the data)

[65 4D]: CRC check data

3. Corresponding parameter table of communication

Numbering from address 0 is as follows:

- 00 Temperature value (°C)
- 02 PH value (pH)
- 04 mV value (mV)
- 06 Current 1 (mA)
- 08 Current 2 (mA)
- 10 Ambient temperature value (°C)



Suzhou Delfino Environmental Technology CO., Ltd
www.daruifuno.com
info@daruifuno.com